



OM-2220

190 444E

March 1999

Processes



Air Plasma Cutting
and Gouging

Description



Air Plasma Cutter

Spectrum[®] 2050

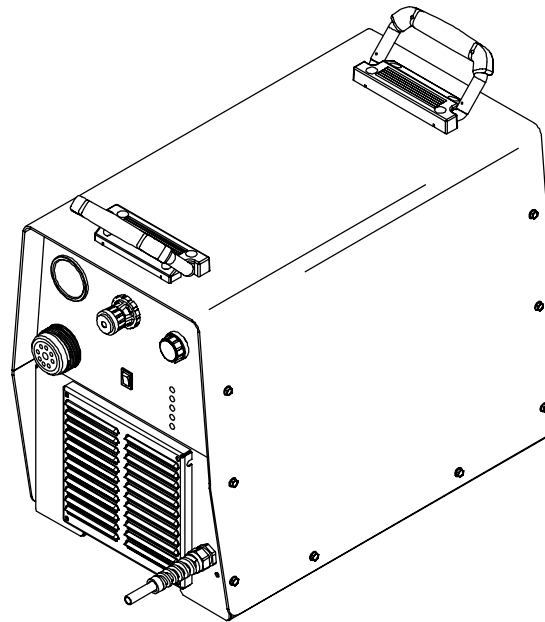

Visit our website at
www.MillerWelds.com

OWNER'S MANUAL

From Miller to You

Thank you and congratulations on choosing Miller. Now you can get the job done and get it done right. We know you don't have time to do it any other way.

That's why when Niels Miller first started building arc welders in 1929, he made sure his products offered long-lasting value and superior quality. Like you, his customers couldn't afford anything less. Miller products had to be more than the best they could be. They had to be the best you could buy.



Today, the people that build and sell Miller products continue the tradition. They're just as committed to providing equipment and service that meets the high standards of quality and value established in 1929.

This Owner's Manual is designed to help you get the most out of your Miller products. Please take time to read the Safety precautions. They will help you protect yourself against potential hazards on the worksite. We've



Miller is the first welding equipment manufacturer in the U.S.A. to be registered to the ISO 9001 Quality System Standard.

made installation and operation quick and easy. With Miller you can count on years of reliable service with proper maintenance. And if for some reason the unit needs repair, there's a Troubleshooting section that will help you figure out what the problem is. The parts list will then help you to decide which exact part you may need to fix the problem. Warranty and service information for your particular model are also provided.

Miller Electric manufactures a full line of welders and welding related equipment. For information on other quality Miller products, contact your local Miller distributor to receive the latest full line catalog or individual catalog sheets. To locate your nearest distributor call 1-800-4-A-Miller.



Working as hard as you do – every power source from Miller is backed by the most hassle-free warranty in the business.

Miller offers a Technical Manual which provides more detailed service and parts information for your unit. To obtain a Technical Manual, contact your local distributor. Your distributor can also supply you with Welding Process Manuals such as SMAW, GTAW, GMAW, and GMAW-P.



TABLE OF CONTENTS

WARNING

This product, when used for welding or cutting, produces fumes or gases which contain chemicals known to the State of California to cause birth defects and, in some cases, cancer. (California Health & Safety Code Section 25249.5 et seq.)

SECTION 1 – SAFETY PRECAUTIONS - READ BEFORE USING	1
1-1. Symbol Usage	1
1-2. Plasma Arc Cutting Hazards	1
1-3. Additional Symbols For Installation, Operation, And Maintenance	2
1-4. Principal Safety Standards	3
1-5. EMF Information	4
SECTION 1 – CONSIGNES DE SÉCURITÉ – LIRE AVANT UTILISATION	5
1-1. Signification des symboles	5
1-2. Dangers liés au coupage à l'arc au plasma	5
1-3. Dangers supplémentaires en relation avec l'installation, le fonctionnement et la maintenance	7
1-4. Principales normes de sécurité	7
1-5. Information sur les champs électromagnétiques	8
SECTION 2 – INSTALLATION	9
2-1. Specifications	9
2-2. Duty Cycle and Overheating	10
2-3. Cutting Speed	10
2-4. Selecting a Location	11
2-5. Connecting Work Clamp and Gas/Air Supply	12
2-6. Electrical Service Guide	12
2-7. Connecting Input Power	13
SECTION 3 – OPERATION	14
3-1. Controls	14
3-2. Setting Gas/Air Pressure	15
3-3. Sequence of Operation	16
SECTION 4 – MAINTENANCE & TROUBLESHOOTING	17
4-1. Routine Maintenance	17
4-2. Trouble Lights	18
4-3. Checking Shield Cup Shutdown System	18
4-4. Troubleshooting	19
SECTION 5 – ELECTRICAL DIAGRAM	20
SECTION 6 – PARTS LIST	22

SECTION 1 – SAFETY PRECAUTIONS - READ BEFORE USING

pom_nd_9/98

1-1. Symbol Usage



Means Warning! Watch Out! There are possible hazards with this procedure! The possible hazards are shown in the adjoining symbols.

▲ Marks a special safety message.

☞ Means "Note"; not safety related.



This group of symbols means Warning! Watch Out! possible ELECTRIC SHOCK, MOVING PARTS, and HOT PARTS hazards. Consult symbols and related instructions below for necessary actions to avoid the hazards.

1-2. Plasma Arc Cutting Hazards

▲ The symbols shown below are used throughout this manual to call attention to and identify possible hazards. When you see the symbol, watch out, and follow the related instructions to avoid the hazard. The safety information given below is only a summary of the more complete safety information found in the Safety Standards listed in Section 1-4. Read and follow all Safety Standards.

▲ Only qualified persons should install, operate, maintain, and repair this unit.

▲ During operation, keep everybody, especially children, away.

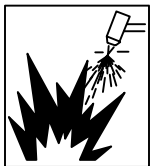

CUTTING can cause fire or explosion.

Hot metal and sparks blow out from the cutting arc. The flying sparks and hot metal, hot workpiece, and hot equipment can cause fires and burns. Check and be sure the area is safe before doing any cutting.

- Protect yourself and others from flying sparks and hot metal.
- Do not cut where flying sparks can strike flammable material.
- Remove all flammables within 35 ft (10.7 m) of the cutting arc. If this is not possible, tightly cover them with approved covers.
- Be alert that sparks and hot materials from cutting can easily go through small cracks and openings to adjacent areas.
- Watch for fire, and keep a fire extinguisher nearby.
- Be aware that cutting on a ceiling, floor, bulkhead, or partition can cause fire on the hidden side.
- Do not cut on closed containers such as tanks or drums.
- Connect work cable to the work as close to the cutting area as practical to prevent cutting current from traveling long, possibly unknown paths and causing electric shock and fire hazards.
- Never cut containers with potentially flammable materials inside – they must be emptied and properly cleaned first.
- Do not cut in atmospheres containing explosive dust or vapors.
- Do not cut pressurized cylinders, pipes, or vessels.
- Do not cut containers that have held combustibles.
- Wear oil-free protective garments such as leather gloves, heavy shirt, cuffless trousers, high shoes, and a cap.
- Do not locate unit on or over combustible surfaces.
- Remove any combustibles, such as a butane lighter or matches, from your person before doing any cutting.



ELECTRIC SHOCK can kill.

Touching live electrical parts can cause fatal shocks or severe burns. The torch and work circuit are electrically live whenever the output is on. The input power circuit and machine internal circuits are also live when power is on. Plasma arc cutting requires

higher voltages than welding to start and maintain the arc (200 to 400 volts dc are common), but also uses torches designed with safety interlock systems which turn off the machine when the shield cup is loosened or if tip touches electrode inside the nozzle. Incorrectly installed or improperly grounded equipment is a hazard.



ELECTRIC SHOCK can kill.

SIGNIFICANT DC VOLTAGE exists on internal parts of inverter power sources AFTER the removal of input power.

- Turn Off unit, disconnect input power, check voltage on input capacitors, and be sure it is near zero (0) volts before touching any parts. Check capacitors according to instructions in Maintenance Section of Owner's Manual or Technical Manual before touching any parts.

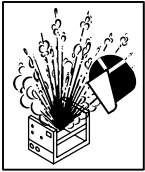

EXPLODING PARTS can injure.

- On inverter power sources, failed parts can explode or cause other parts to explode when power is applied. Always wear a face shield and long sleeves when servicing inverters.

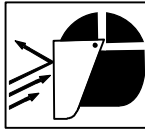

FLYING SPARKS can cause injury.

Sparks and hot metal blow out from the cutting arc. Chipping and grinding cause flying metal.

- Wear approved face shield or safety goggles with side shields.
- Wear proper body protection to protect skin.
- Wear flame-resistant ear plugs or ear muffs to prevent sparks from entering ears.

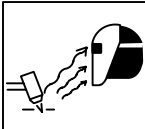

ARC RAYS can burn eyes and skin.

Arc rays from the cutting process produce intense visible and invisible (ultraviolet and infrared) rays that can burn eyes and skin.

- Wear face protection (helmet or shield) with correct shade of filter to protect your face and eyes when cutting or watching. ANSI Z49.1 (see Safety Standards) suggests a No. 9 shade (with No. 8 as minimum) for all cutting currents less than 300 amperes. Z49.1 adds that lighter filter shades may be used when the arc is hidden by the workpiece. As this is normally the case with low current cutting, the shades suggested in Table 1 are provided for the operator's convenience.
- Wear approved safety glasses with side shields under your helmet or shield.
- Use protective screens or barriers to protect others from flash and glare; warn others not to watch the arc.
- Wear protective clothing made from durable, flame-resistant material (leather and wool) and foot protection.

Table 1. Eye Protection For Plasma Arc Cutting

Current Level In Amperes	Minimum Shade Number	
Below 20		#4
20 – 40		#5
40 – 60		#6
60 – 80		#8

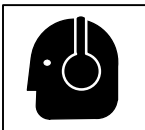

NOISE can damage hearing.

Prolonged noise from some cutting applications can damage hearing if levels exceed limits specified by OSHA (see Safety Standards).

- Use approved ear plugs or ear muffs if noise level is high.
- Warn others nearby about noise hazard.



FUMES AND GASES can be hazardous.

Cutting produces fumes and gases. Breathing these fumes and gases can be hazardous to your health.

- Keep your head out of the fumes. Do not breathe the fumes.

- If inside, ventilate the area and/or use exhaust at the arc to remove cutting fumes and gases.
- If ventilation is poor, use an approved air-supplied respirator.
- Read the Material Safety Data Sheets (MSDSs) and the manufacturer's instruction for metals to be cut, coatings, and cleaners.
- Work in a confined space only if it is well ventilated, or while wearing an air-supplied respirator. Fumes from cutting and oxygen depletion can alter air quality causing injury or death. Be sure the breathing air is safe.
- Do not cut in locations near degreasing, cleaning, or spraying operations. The heat and rays of the arc can react with vapors to form highly toxic and irritating gases.
- Do not cut on coated metals, such as galvanized, lead, or cadmium plated steel, unless the coating is removed from the cutting area, the area is well ventilated, and if necessary, while wearing an air-supplied respirator. The coatings and any metals containing these elements can give off toxic fumes when cut.
- Do not cut containers with toxic or reactive materials inside or containers that have held toxic or reactive materials – they must be emptied and properly cleaned first.

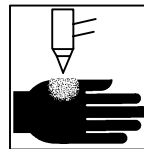

PLASMA ARC can cause injury.

The heat from the plasma arc can cause serious burns. The force of the arc adds greatly to the burn hazard. The intensely hot and powerful arc can quickly cut through gloves and tissue.

- Keep away from the torch tip.
- Do not grip material near the cutting path.
- The pilot arc can cause burns – keep away from torch tip when trigger is pressed.
- Wear proper flame-retardant clothing covering all exposed body areas.
- Point torch away from your body and toward work when pressing the torch trigger – pilot arc comes on immediately.
- Turn off power source and disconnect input power before disassembling torch or changing torch parts.
- Use only torch(es) specified in the Owner's Manual.

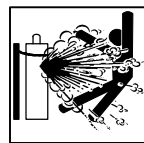

CYLINDERS can explode if damaged.

Gas cylinders contain gas under high pressure. If damaged, a cylinder can explode. Since gas cylinders are normally part of metalworking processes, be sure to treat them carefully.

- Protect compressed gas cylinders from excessive heat, mechanical shocks, slag, open flame, sparks, and arcs.
- Install and secure cylinders in an upright position by chaining them to a stationary support or equipment cylinder rack to prevent falling or tipping.
- Keep cylinders away from any cutting or other electrical circuits.
- Never allow electrical contact between a plasma arc torch and a cylinder.
- Never cut on a pressurized cylinder – explosion will result.
- Use only correct gas cylinders, regulators, hoses, and fittings designed for the specific application; maintain them and associated parts in good condition.
- Turn face away from valve outlet when opening cylinder valve.
- Keep protective cap in place over valve except when cylinder is in use or connected for use.
- Read and follow instructions on compressed gas cylinders, associated equipment, and CGA publication P-1 listed in Safety Standards.

1-3. Additional Symbols For Installation, Operation, And Maintenance



HOT PARTS can cause severe burns.

- Do not touch hot parts bare handed.
- Allow cooling period before working on torch.



MOVING PARTS can cause injury.

- Keep away from moving parts such as fans.
- Keep all doors, panels, covers, and guards closed and securely in place.

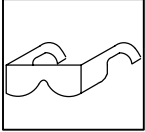

FLYING METAL can injure eyes.

- Wear safety glasses with side shields or face shield.

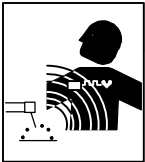

MAGNETIC FIELDS can affect pacemakers.

- Pacemaker wearers keep away.
- Wearers should consult their doctor before going near plasma arc cutting operations.

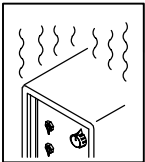

OVERUSE can cause OVERHEATING.

- Allow cooling period; follow rated duty cycle.
- Reduce amperage (thickness) or reduce duty cycle before starting to cut again.



EXPLODING HYDROGEN hazard.

- When cutting aluminum underwater or with the water touching the underside of the aluminum, free hydrogen gas may collect under the work-piece.

- See your cutting engineer and water table instructions for help.



FALLING UNIT can cause injury.

- Use lifting eye to lift unit only, NOT running gear, gas cylinders, or any other accessories.
- Use equipment of adequate capacity to lift unit.

- If using lift forks to move unit, be sure forks are long enough to extend beyond opposite side of unit.



FIRE OR EXPLOSION hazard.

- Do not locate unit on, over, or near combustible surfaces.
- Do not install unit near flammables.
- Do not overload building wiring – be sure power supply system is properly sized, rated, and protected to handle this unit.

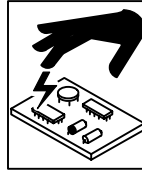

STATIC (ESD) can damage PC boards.

- Put on grounded wrist strap BEFORE handling boards or parts.
- Use proper static-proof bags and boxes to store, move, or ship PC boards.

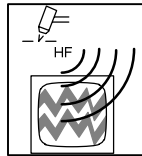

H.F. RADIATION can cause interference.

- High frequency (H.F.) can interfere with radio navigation, safety services, computers, and communications equipment.
- Have only qualified persons familiar with electronic equipment perform this installation.
- The user is responsible for having a qualified electrician promptly correct any interference problem resulting from the installation.
- If notified by the FCC about interference, stop using the equipment at once.
- Have the installation regularly checked and maintained.
- Keep high-frequency source doors and panels tightly shut, keep spark gaps at correct setting, and use grounding and shielding to minimize the possibility of interference.

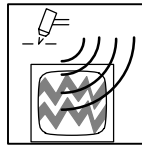

ARC CUTTING can cause interference.

- Electromagnetic energy can interfere with sensitive electronic equipment such as computers and computer-driven equipment such as robots.
- To reduce possible interference, keep cables as short as possible, close together, and down low, such as on the floor.
- Locate cutting operation 100 meters from any sensitive electronic equipment.
- Be sure this cutting power source is installed and grounded according to this manual.
- If interference still occurs, the user must take extra measures such as moving the machine, using shielded cables, using line filters, or shielding the work area.

1-4. Principal Safety Standards

Safety in Welding and Cutting, ANSI Standard Z49.1, from American Welding Society, 550 N.W. LeJeune Rd, Miami FL 33126

Safety and Health Standards, OSHA 29 CFR 1910, from Superintendent of Documents, U.S. Government Printing Office, Washington, D.C. 20402.

Recommended Practices for Plasma Arc Cutting, American Welding Society Standard AWS C5.2, from American Welding Society, 550 N.W. LeJeune Rd, Miami, FL 33126

Recommended Safe Practices for the Preparation for Welding and Cutting of Containers That Have Held Hazardous Substances, American Welding Society Standard AWS F4.1, from American Welding Society, 550 N.W. LeJeune Rd, Miami, FL 33126

National Electrical Code, NFPA Standard 70, from National Fire Protection Association, Batterymarch Park, Quincy, MA 02269.

Safe Handling of Compressed Gases in Cylinders, CGA Pamphlet P-1, from Compressed Gas Association, 1235 Jefferson Davis Highway, Suite 501, Arlington, VA 22202.

Code for Safety in Welding and Cutting, CSA Standard W117.2, from Canadian Standards Association, Standards Sales, 178 Rexdale Boulevard, Rexdale, Ontario, Canada M9W 1R3.

Safe Practices For Occupation And Educational Eye And Face Protection, ANSI Standard Z87.1, from American National Standards Institute, 1430 Broadway, New York, NY 10018.

Cutting And Welding Processes, NFPA Standard 51B, from National Fire Protection Association, Batterymarch Park, Quincy, MA 02269.

1-5. EMF Information

Considerations About Welding Or Cutting And The Effects Of Low Frequency Electric And Magnetic Fields

Welding or cutting current, as it flows through the welding or cutting cables, will cause electromagnetic fields. There has been and still is some concern about such fields. However, after examining more than 500 studies spanning 17 years of research, a special blue ribbon committee of the National Research Council concluded that: "The body of evidence, in the committee's judgment, has not demonstrated that exposure to power-frequency electric and magnetic fields is a human-health hazard." However, studies are still going forth and evidence continues to be examined. Until the final conclusions of the research are reached, you may wish to minimize your exposure to electromagnetic fields when welding or cutting.

To reduce magnetic fields in the workplace, use the following procedures:

1. Keep cables close together by twisting or taping them.
2. Arrange cables to one side and away from the operator.
3. Do not coil or drape cables around your body.
4. Keep cutting power source and cables as far away from operator as practical.
5. Connect work clamp to workpiece as close to the cut as possible.

About Pacemakers:

Pacemaker wearers consult your doctor first. If cleared by your doctor, then following the above procedures is recommended.

SECTION 1 – CONSIGNES DE SÉCURITÉ – LIRE AVANT UTILISATION

pom_nd_fre_5/97

1-1. Signification des symboles



Signifie Mise en garde ! Soyez vigilant ! Cette procédure présente des risques de danger ! Ceux-ci sont identifiés par des symboles adjacents aux directives.

▲ Identifie un message de sécurité particulier.

☞ Signifie NOTA ; n'est pas relatif à la sécurité.



Ce groupe de symboles signifie Mise en garde ! Soyez vigilant ! Il y a des risques de danger reliés aux CHOCS ÉLECTRIQUES, aux PIÈCES EN MOUVEMENT et aux PIÈCES CHAUDES. Reportez-vous aux symboles et aux directives ci-dessous afin de connaître les mesures à prendre pour éviter tout danger.

1-2. Dangers liés au coupage à l'arc au plasma

▲ Les symboles présentés ci-après sont utilisés tout au long du présent manuel pour attirer votre attention et identifier les risques de danger. Lorsque vous voyez un symbole, soyez vigilant et suivez les directives mentionnées afin d'éviter tout danger. Les consignes de sécurité présentées ci-après ne font que résumer l'information contenue dans les normes de sécurité énumérées à la section 1-5. Veuillez lire et respecter toutes ces normes de sécurité.

▲ L'installation, l'utilisation, l'entretien et les réparations ne doivent être confiés qu'à des personnes qualifiées.

▲ Au cours de l'utilisation, tenir toute personne à l'écart et plus particulièrement les enfants.

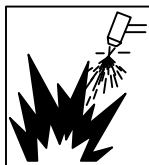

LE COUPAGE présente un risque de feu ou d'explosion.

Des particules de métal chaud et des étincelles peuvent jaillir de la pièce au moment du coupage. Les étincelles et le métal chaud, la pièce à couper chauffée et l'équipement chaud peuvent causer un feu ou des brûlures. Avant de commencer à travailler, assurez-vous que l'endroit est sécuritaire.

- Protégez-vous, ainsi que toute autre personne travaillant sur les lieux, contre les étincelles et le métal chaud.
- Ne coupez pas dans un endroit où des étincelles pourraient atteindre des matières inflammables.
- Déplacez toute matière inflammable se trouvant à l'intérieur d'un périmètre de 10,7 m (35 pi) de la pièce à couper. Si cela est impossible, vous devez les couvrir avec des housses approuvées et bien ajustées.
- Assurez-vous qu'aucune étincelle ni particule de métal ne peut se glisser dans de petites fissures ou tomber dans d'autres pièces.
- Afin d'éliminer tout risque de feu, soyez vigilant et gardez toujours un extincteur à la portée de la main.
- Si vous coupez sur un plafond, un plancher ou une cloison, soyez conscient que cela peut entraîner un feu de l'autre côté.
- Ne coupez pas sur un contenant fermé tel qu'un réservoir ou un bidon.
- Fixez le câble de masse sur la pièce à couper, le plus près possible de la zone à couper afin de prévenir que le courant de coupage ne prenne une trajectoire inconnue ou longue et ne cause ainsi une décharge électrique ou un feu.
- Ne coupez jamais des contenants qui peuvent contenir des matières inflammables. Vous devez en premier lieu les vider et les nettoyer convenablement.
- Ne coupez pas dans un endroit où l'atmosphère risque de contenir de la poussière ou des vapeurs explosives.
- Ne coupez pas de bouteilles, de tuyaux ou de contenants pressurisés.
- Ne coupez pas de contenants qui ont déjà reçu des combustibles.
- Portez des vêtements de protection exempts d'huile tels que des gants en cuir, une veste résistante, des pantalons sans revers, des bottes et un casque.
- Ne placez pas le poste sur une surface combustible ou au-dessus de celle-ci.
- Avant le coupage, retirez tout combustible de vos poches, par exemple un briquet au butane ou des allumettes.



UNE DÉCHARGE ÉLECTRIQUE peut entraîner la mort.

Le fait de toucher à une pièce électrique sous tension peut donner une décharge fatale ou entraîner des brûlures graves. Le chalumeau et le circuit de masse sont automatiquement actifs lorsque le poste est sous tension. L'alimentation d'entrée et les circuits internes de l'appareil le sont également. Le coupage au plasma d'arc exige des tensions plus élevées que le soudage pour amorcer et maintenir l'arc (souvent de 200 à 400 V CC), c'est pourquoi on fait appel à des chalumeaux conçus avec un système de verrouillage sécuritaire qui met l'appareil hors tension lorsque la capsule anti-feu est desserrée ou si le tube touche l'électrode à l'intérieur de la buse. Un poste incorrectement installé ou inadéquatement mis à la terre constitue un danger.

- Ne touchez pas aux pièces électriques sous tension.
- Portez des gants isolants et des vêtements de protection secs et sans trous.
- Isolez-vous de la pièce à couper et du sol en utilisant des housses ou des tapis assez grands afin d'éviter tout contact physique avec la pièce à couper ou le sol.
- Ne touchez pas aux pièces du chalumeau si vous êtes en contact avec la pièce à couper ou le sol.
- Mettez l'appareil hors tension avant d'effectuer la vérification, le nettoyage ou le changement d'une pièce du chalumeau.
- Coupez l'alimentation d'entrée avant d'installer l'appareil ou d'effectuer l'entretien. Verrouillez ou étiquetez la sortie d'alimentation selon la norme OSHA 29 CFR 1910.147 (reportez-vous aux Principales normes de sécurité).
- Installez le poste correctement et mettez-le à la terre convenablement selon les consignes du manuel de l'opérateur et les normes nationales, provinciales et locales.
- Assurez-vous que le fil de terre du cordon d'alimentation est correctement relié à la borne de terre dans la boîte de coupure ou que la fiche du cordon est branchée à une prise correctement mise à la terre – vous devez toujours vérifier la mise à la terre.
- Avant d'effectuer les connexions d'alimentation, vous devez relier le bon fil de terre.
- Vérifiez fréquemment le cordon d'alimentation afin de vous assurer qu'il n'est pas altéré ou à nu, remplacez-le immédiatement s'il l'est. Un fil à nu peut entraîner la mort.
- L'équipement doit être hors tension lorsqu'il n'est pas utilisé.
- Vérifiez et remplacez les cosses du câble du chalumeau si elles sont usées ou altérées.
- Le câble du chalumeau ne doit pas s'enrouler autour de votre corps.
- Si les normes le stipulent, la pièce à couper doit être mise à la terre.
- Utilisez uniquement de l'équipement en bonne condition. Réparez ou remplacez immédiatement toute pièce altérée.
- Portez un harnais de sécurité si vous devez travailler au-dessus du sol.
- Assurez-vous que tous les panneaux et couvercles sont correctement en place.
- N'essayez pas d'aller à l'encontre des systèmes de verrouillage de sécurité ou de les contourner.
- Utilisez uniquement le ou les chalumeaux recommandés dans le manuel de l'opérateur.

- N'approchez pas le tube du chalumeau et l'arc pilote lorsque la gâchette est enfoncée.
- Le câble de masse doit être pincé correctement sur la pièce à couper, métal contre métal (et non de telle sorte qu'il puisse se détacher), ou sur la table de travail le plus près possible de la ligne de coupage.
- Isoler la pince de masse quand pas mis à la pièce pour éviter le contact avec tout objet métallique.

Il y a DU COURANT CONTINU IMPORTANT dans les convertisseurs après la suppression de l'alimentation électrique.

- Arrêter les convertisseurs, débrancher le courant électrique, et décharger les condensateurs d'alimentation selon les instructions indiquées dans la partie entretien avant de toucher les pièces.

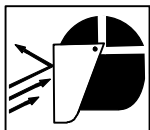

LES ÉTINCELLES VOLANTES risquent de provoquer des blessures.

Le coupage plasma produit des étincelles et projections de métal à très haute température. Lorsque la pièce refroidit, du laitier peut se former.

- Portez une visière ou des lunettes de sécurité avec des écrans latéraux approuvés.
- Portez des vêtements de protection adéquats afin de protéger votre peau.
- Ayez recours à des protège-tympons ou à un serre-tête ignifuges afin d'éviter que les étincelles n'entrent dans vos oreilles.

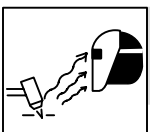

LES RAYONS D'ARC peuvent entraîner des brûlures aux yeux et à la peau.

Les rayons d'arc provenant du procédé de coupage produisent des rayons visibles et invisibles intenses (ultraviolets et infrarouges) qui peuvent entraîner des brûlures aux yeux et à la peau.

- Lorsque vous coupez ou regardez quelqu'un couper, portez un masque ou un écran facial avec le filtre approprié. La norme ANSI Z49.1 (reportez-vous aux Principales normes de sécurité) suggère d'utiliser un filtre de teinte n° 9 (n° 8 étant le minimum) pour tout travail de coupage faisant appel à un courant de moins de 300 A. On mentionne également dans la norme Z49.1 qu'un filtre plus faible peut être utilisé lorsque l'arc est caché par la pièce à couper. Comme cela est habituellement le cas pour les travaux de coupage à faible courant, les teintes énumérées au tableau 1 sont fournies à titre d'information pour l'opérateur.
- Porter des lunettes de sécurité à coques latérales sous votre casque ou écran facial.
- Ayez recours à des écrans protecteurs ou à des rideaux pour protéger les autres contre les rayonnements et les éblouissements; prévenez toute personne sur les lieux de ne pas regarder l'arc.
- Portez des vêtements confectionnés avec des matières résistantes et ignifuges (cuir et laine) et des bottes de protection.

Tableau 1. Protection des yeux pour le coupage au plasma d'arc

Intensité de courant en ampères	Filtre de teinte (minimum)	
Moins de 20		no. 4
20 – 40		no. 5
40 – 60		no. 6
60 – 80		no. 8



LE BRUIT peut endommager l'ouïe.

Certaines applications de coupage produisent un bruit constant, ce qui peut endommager l'ouïe si le niveau sonore dépasse les limites permises par l'OSHA (reportez-vous aux Principales normes de sécurité).

- Utilisez des protège-tympons ou un serre-tête antibruit si le niveau sonore est élevé.
- Prévenez toute personne sur les lieux du danger relié au bruit.



LES FUMÉES ET LES GAZ peuvent être dangereux.

Le coupage produit des vapeurs et des gaz. Respirer ces vapeurs et ces gaz peut être dangereux pour la santé.

- Ne mettez pas votre tête au-dessus des vapeurs. Ne respirez pas ces vapeurs.
- Si vous êtes à l'intérieur au moment du coupage, ventilez la pièce ou ayez recours à une ventilation aspirante installée près de l'arc pour évacuer les vapeurs et les gaz.
- Si la ventilation est médiocre, utilisez un respirateur anti-vapeurs approuvé.
- Veuillez lire le Material Safety Data Sheets (MSDS) et les instructions du fabricant pour obtenir plus de renseignements sur les métaux à couper, les enrobages et les nettoyants.
- Travaillez dans un espace restreint uniquement s'il est bien ventilé ou si vous portez un respirateur anti-vapeurs. Les vapeurs causées par le coupage et l'épuisement de l'oxygène peuvent altérer la qualité de l'air et entraîner des blessures ou la mort. Assurez-vous que l'air ambiant est sain pour la santé.
- Ne coupez pas dans un endroit près d'opérations de décapage, de nettoyage ou de vaporisation. La chaleur et les rayons d'arc peuvent réagir avec les vapeurs et former des gaz hautement toxiques et irritants.
- Ne coupez pas des métaux enrobés tels que des métaux galvanisés, contenant du plomb ou de l'acier plaqué au cadmium, à moins que l'enrobage ne soit ôté de la surface du métal à couper, que l'endroit où vous travaillez ne soit bien ventilé, ou, si nécessaire, que vous ne portiez un respirateur anti-vapeurs. Les enrobages ou tous métaux qui contiennent ces éléments peuvent créer des vapeurs toxiques s'ils sont coupés.
- Ne coupez pas de contenants qui renferment ou ont renfermés des matières toxiques ou réactives – vous devez en premier lieu les vider et les nettoyer convenablement.

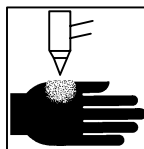

LE PLASMA D'ARC peut entraîner des blessures.

La chaleur dégagée par le plasma d'arc peut entraîner de sérieuses brûlures. La force de l'arc est un facteur qui s'ajoute au danger de brûlures. La chaleur intense et la puissance de l'arc peuvent rapidement passer au travers de gants et de tissus.

- N'approchez pas le tube du chalumeau.
- Ne saisissez pas la pièce à couper près de la ligne de coupage.
- L'arc pilote peut causer des brûlures – n'approchez pas le tube du chalumeau lorsque vous avez appuyé sur la gâchette.
- Portez des vêtements de protection adéquats qui recouvrent tout votre corps.
- Ne pointez pas le chalumeau en direction de votre corps ni de la pièce à couper lorsque vous appuyez sur la gâchette – l'arc pilote s'allume automatiquement.
- Mettez l'alimentation hors tension et débranchez le cordon d'alimentation avant de démonter le chalumeau ou de changer une pièce du chalumeau.
- Utilisez uniquement le ou les chalumeaux recommandés dans le manuel de l'opérateur.

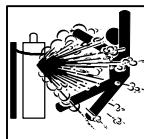

LES BOUTEILLES peuvent exploser si elles sont endommagées.

Les bouteilles de gaz contiennent du gaz sous haute pression. Si une bouteille est endommagée, elle peut exploser. Puisque les bouteilles de gaz font habituellement partie d'un processus de travail des métaux, assurez-vous de les manipuler correctement.

- Protégez les bouteilles de gaz comprimé contre la chaleur excessive, les chocs mécaniques, le laitier, la flamme, les étincelles et l'arc.
- Installez et attachez les bouteilles dans la position verticale à l'aide d'une chaîne, sur un support stationnaire ou un châssis porte-bouteille afin de prévenir qu'elles ne tombent ou ne basculent.
- Les bouteilles ne doivent pas être près de la zone de coupage ni de tout autre circuit électrique.
- Un contact électrique ne doit jamais se produire entre un chalumeau de plasma d'arc et une bouteille.
- Ne coupez jamais sur une bouteille pressurisée – une explosion en résulterait.
- Utilisez uniquement des bouteilles de gaz, des détendeurs, des boyaux et des raccords conçus pour l'application déterminée. Gardez-les, ainsi que toute autre pièce associée, en bonne condition.
- Détournez votre visage du détendeur-régulateur lorsque vous ouvrez la soupape de la bouteille.
- Le couvercle du détendeur doit toujours être en place, sauf lorsque vous utilisez la bouteille ou qu'elle est reliée pour usage ultérieur.
- Lisez et suivez les instructions sur les bouteilles de gaz comprimé, l'équipement connexe et le dépliant P-1 de la CGA mentionné dans les Principales normes de sécurité.

1-3. Dangers supplémentaires en relation avec l'installation, le fonctionnement et la maintenance



DES PIÈCES CHAUDES peuvent provoquer des brûlures graves.

- Ne pas toucher des parties chaudes à mains nues.
- Laisser refroidir avant d'intervenir sur la torche.



DES ORGANES MOBILES peuvent provoquer des blessures.

- S'abstenir de toucher des organes mobiles tels que des ventilateurs.
- Maintenir fermés et verrouillés les portes, panneaux, recouvrements et dispositifs de protection.

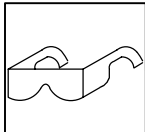

DES PARTICULES VOLANTES peuvent blesser les yeux.

- Porter des lunettes de sécurité avec protections latérales ou frontales.

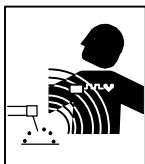

LES CHAMPS MAGNÉTIQUES peuvent affecter les stimulateurs cardiaques.

- Porteurs de stimulateur cardiaque, restez à distance.
- Les porteurs sont priés de consulter leur médecin avant d'approcher les opérations de coupage plasma.

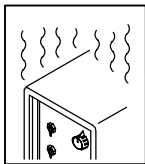

L'EMPLOI EXCESSIF peut SURCHAUFFER L'ÉQUIPEMENT.

- Prévoir une période de refroidissement; respecter le cycle opératoire nominal.
- Réduire l'ampérage (épaisseur) avant de continuer à couper ou réduire le facteur de marche.



Danger D'EXPLOSION D'HYDROGÈNE.

- Lors du coupage d'aluminium partiellement ou totalement immergé dans l'eau, de l'hydrogène libre peut s'accumuler sous la pièce.
- Consultez votre ingénieur de coupage et les instructions de la table de coupage.

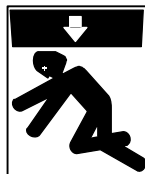

LA CHUTE DE L'APPAREIL peut blesser.

- Utiliser l'anneau de levage uniquement pour soulever l'appareil, NON PAS les chariot, les bouteilles de gaz ou tout autre accessoire.
- Utiliser un engin d'une capacité appropriée pour soulever l'appareil.
- En utilisant des fourches de levage pour déplacer l'unité, s'assurer que les fourches sont suffisamment longues pour dépasser du côté opposé de l'appareil.



Risque D'INCENDIE OU D'EXPLOSION.

- Ne pas placer l'appareil sur, au-dessus ou à proximité de surfaces inflammables.
- Ne pas installer l'appareil à proximité de produits inflammables
- Ne pas surcharger l'installation électrique – s'assurer que l'alimentation est correctement dimensionnée et protégée avant de mettre l'appareil en service.

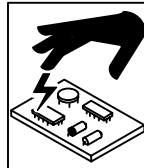

LES CHARGES ÉLECTROSTATIQUES peuvent endommager les circuits imprimés.

- Établir la connexion avec la barrette de terre avant de manipuler des cartes ou des pièces.
- Utiliser des pochettes et des boîtes antistatiques pour stocker, déplacer ou expédier des cartes PC.

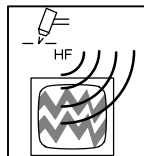

LE RAYONNEMENT HAUTE FRÉQUENCE (H.F.) risque de provoquer des interférences.

- Le Rayonnement haute fréquence (H.F.) peut provoquer des interférences avec les équipements de radio-navigation et de communication, les services de sécurité et les ordinateurs.
- Demander seulement à des personnes qualifiées familiarisées avec des équipements électroniques de faire fonctionner l'installation.
- L'utilisateur est tenu de faire corriger rapidement par un électricien qualifié les interférences résultant de l'installation.
- Si le FCC signale des interférences, arrêter immédiatement l'appareil.
- Effectuer régulièrement le contrôle et l'entretien de l'installation.
- Maintenir soigneusement fermés les portes et les panneaux des sources de haute fréquence, maintenir les éclateurs à une distance correcte et utiliser une terre et un blindage pour réduire les interférences éventuelles.

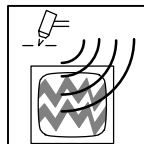

LE COUPAGE À L'ARC peut causer des interférences.

- L'énergie électromagnétique peut gêner le fonctionnement d'appareils électroniques comme des ordinateurs et des robots.
- Pour réduire la possibilité d'interférence, maintenir les câbles aussi courts que possible, les grouper, et les poser aussi bas que possible (ex. par terre).
- Veiller à couper à une distance de 100 mètres de tout équipement électronique sensible.
- S'assurer que la source de coupage est correctement branchée et mise à la terre.
- Si l'interférence persiste, l'utilisateur doit prendre des mesures supplémentaires comme écarter la machine, utiliser des câbles blindés de des filtres, ou boucler la zone de travail.

1-4. Principales normes de sécurité

Safety in Welding and Cutting, norme ANSI Z49.1, de l'American Welding Society, 550 N.W. Lejeune Rd, Miami FL 33126

Safety and Health Standards, OSHA 29 CFR 1910, du Superintendent of Documents, U.S. Government Printing Office, Washington, D.C. 20402.

Recommended Safe Practice for the Preparation for Welding and Cutting of Containers That Have Held Hazardous Substances, norme AWS F4.1, de l'American Welding Society, 550 N.W. Lejeune Rd, Miami FL 33126

National Electrical Code, NFPA Standard 70, de la National Fire Protection Association, Batterymarch Park, Quincy, MA 02269.

Safe Handling of Compressed Gases in Cylinders, CGA Pamphlet P-1, de la Compressed Gas Association, 1235 Jefferson Davis Highway, Suite 501, Arlington, VA 22202.

Règles de sécurité en soudage, coupage et procédés connexes, norme CSA W117.2, de l'Association canadienne de normalisation, vente de normes, 178 Rexdale Boulevard, Rexdale (Ontario) Canada M9W 1R3.

Safe Practices For Occupation And Educational Eye And Face Protection, norme ANSI Z87.1, de l'American National Standards Institute, 1430 Broadway, New York, NY 10018.

Cutting and Welding Processes, norme NFPA 51B, de la National Fire Protection Association, Batterymarch Park, Quincy, MA 02269.

1-5. Information sur les champs électromagnétiques

Données sur le soudage électrique et sur les effets, pour l'organisme, des champs magnétiques basse fréquence

Le courant de soudage ou de coupage passant dans les câbles de puissance crée des champs électromagnétiques. Il y a eu et il y a encore un certain souci à propos de tels champs. Cependant, après avoir examiné plus de 500 études qui ont été faites pendant une période de recherche de 17 ans, un comité spécial ruban bleu du National Research Council a conclu: "L'accumulation de preuves, suivant le jugement du comité, n'a pas démontré que l'exposition aux champs magnétiques et champs électriques à haute fréquence représente un risque à la santé humaine". Toutefois, des études sont toujours en cours et les preuves continuent à être examinées. En attendant que les conclusions finales de la recherche soient établies, il vous serait souhaitable de réduire votre exposition aux champs électromagnétiques pendant le soudage ou le coupage.

Afin de réduire les champs électromagnétiques dans l'environnement de travail, respecter les consignes suivantes :

- 1 Garder les câbles ensemble en les torsadant ou en les attachant avec du ruban adhésif.
- 2 Mettre tous les câbles du côté opposé de l'opérateur.
- 3 Ne pas courber pas et ne pas entourer pas les câbles autour de vous.
- 4 Garder le poste de soudage et les câbles le plus loin possible de vous.
- 5 Relier la pince de masse le plus près possible de la zone de soudure.

Consignes relatives aux stimulateurs cardiaques :

Les consignes mentionnées précédemment font partie de celles destinées aux personnes ayant recours à un stimulateur cardiaque. Veuillez consulter votre médecin pour obtenir plus de détails.

SECTION 2 – INSTALLATION

2-1. Specifications

NOTE 

For any single or three phase voltage from 208 V to 575 V, the Amperes Input at Rated Load Output is the same for 50 Hertz or 60 Hertz input power. For example, the amperes input for 230 V, 50 Hz, single-phase input power is 35 amperes. The amperes input for 230 V, 60 Hz, single-phase input power is also 35 amperes.

60 Hz	Amperes Input at Rated Load Output 60 Hz				KVA	KW	Rated Output	Type of Output	Plasma Gas	Rated Cutting Capacity	Maximum Open-Circuit Voltage DC
	208 V	230 V	460 V	575 V							
Single-Phase	35	31	16	13	7.2	6.9	50 A @ 110 Volts DC, 30% Duty Cycle	Direct Current, Straight Polarity (DCEN)	Air Or Nitrogen Only	0.7 in (18 mm) At 10 IPM	280
3-Phase	19	17	9	8	6.9 (7.9 for 575 V input)	6.6	50 A @ 110 Volts DC, 60% Duty Cycle				

50 Hz	Amperes Input at Rated Load Output 50 Hz				KVA	KW	Rated Output	Type of Output	Plasma Gas	Rated Cutting Capacity	Maximum Open-Circuit Voltage DC
	230 V	380 V	400 V	415 V							
Single-Phase	31	18	18	18	7.2	6.9	50 A @ 110 Volts DC, 30% Duty Cycle	Direct Current, Straight Polarity (DCEN)	Air Or Nitrogen Only	0.7 in (18 mm) At 10 IPM	280
3-Phase	17	10	10	10	6.9	6.6	50 A @ 110 Volts DC, 60% Duty Cycle				

2-2. Duty Cycle and Overheating



Duty Cycle is percentage of 10 minutes that unit can cut at rated load without overheating.

If unit overheats, thermostat(s) opens, output stops, and cooling fan runs. Wait fifteen minutes for unit to cool. Reduce amperage or duty cycle before cutting.

▲ Exceeding duty cycle can damage unit and void warranty.

Three-Phase Input Power:
60% Duty Cycle

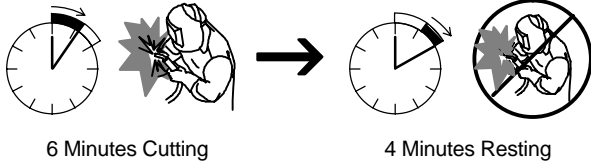

Single-Phase Input Power:
30% Duty Cycle

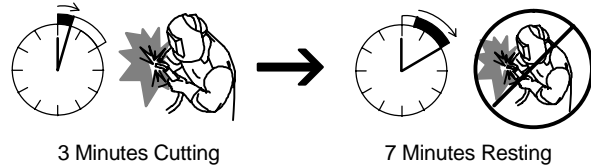

Overheating

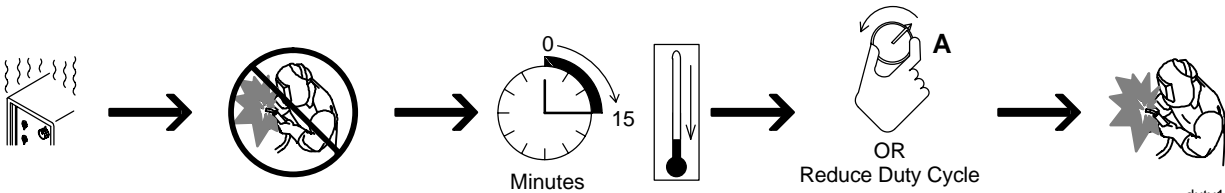

duty1 4/95

2-3. Cutting Speed

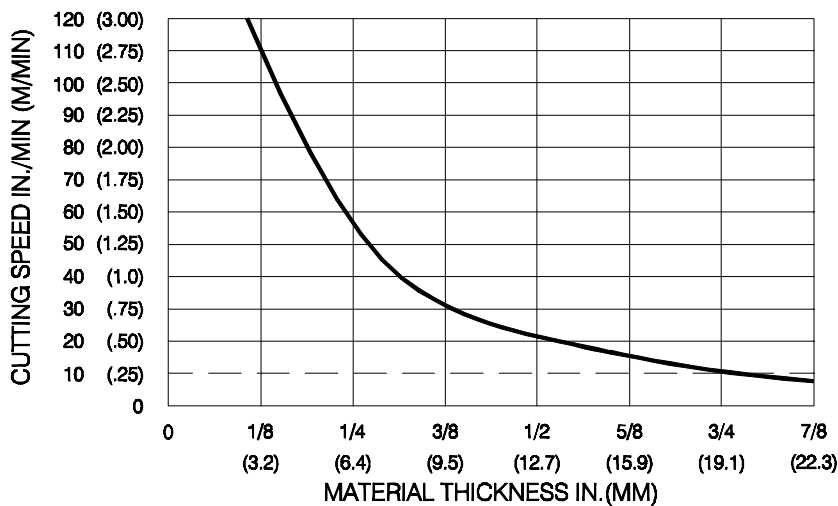

The cutting speed curve shows the recommended maximum cutting speed capabilities of the power source and torch for mild steel of various thickness.

▲ Exceeding recommended cutting speeds will cause rapid erosion of the tip and electrode.

☞ Cutting speed is approximately 10 inches per minute at 0.75 in (19 mm) mild steel thickness at max setting/tip saver mode.

ST-191 830

2-4. Selecting a Location



Dimensions And Weight

70 lb (31.8 kg)

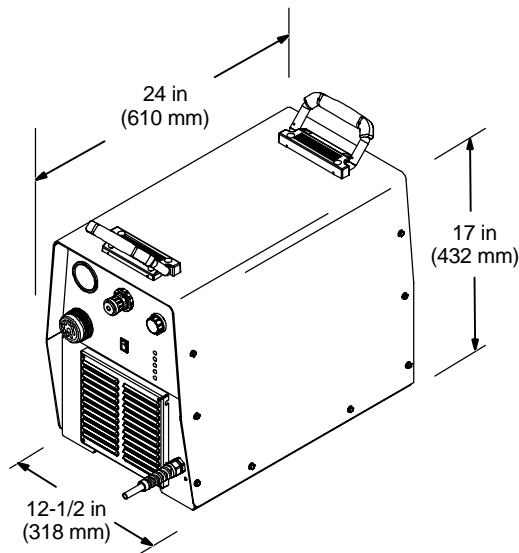

Movement

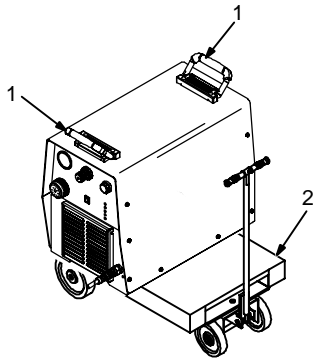

▲ Do not move or operate unit where it could tip.

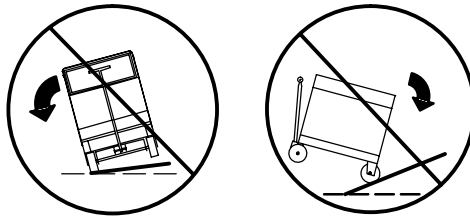

1 Lifting Handles

Use handles to lift unit.

2 Hand Cart

Use cart or similar device to move unit.

3 Rating Data on Rear Nameplate

Use rating data to determine input power needs.

4 Line Disconnect Device

Locate unit near correct input power supply.

▲ Special installation may be required where gasoline or volatile liquids are present – see NEC Article 511 or CEC Section 20.

Location

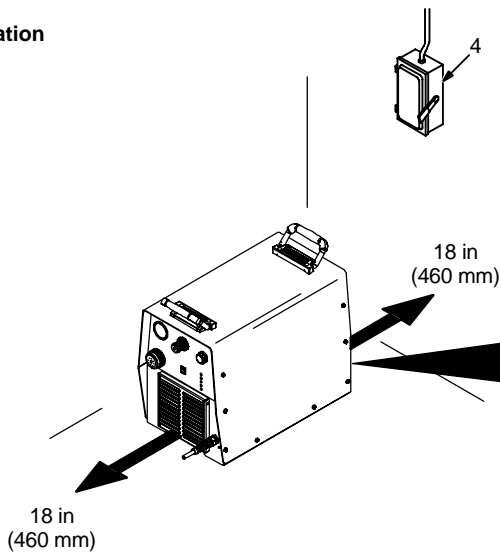

Rated Input				
Volts @ 50/60 Hz	208	230	460	575
Amps (1~/3~)	(35/19)	(31/17)	(16/9)	(13/8)
Rated Output				
Volts - 110 DC	Amps - 50 DC	Air pressure 70 PSI		
Max OCV 280 DC	Duty Cycle	3~ 60%	1~ 30%	

loc_2 3/96 - Ref. ST-151 556 / ST-802 183

2-5. Connecting Work Clamp and Gas/Air Supply

1 Work Clamp
2 Workpiece

Connect work clamp to a clean, paint-free location on workpiece, as close to cutting area as possible.

☞ Use only clean, dry air with 90 to 150 psi (620 to 1035 kPa) pressure.

3 Gas/Air Inlet Opening
4 Hose

☞ Hose must have a minimum inside diameter of 3/8 in (9.5 mm).

5 Teflon Tape

Obtain hose with 1/4 NPT right-hand thread fitting. Wrap threads with teflon tape (optional) or apply pipe sealant, and install fitting in opening. Route hose to gas/air supply.

Adjust gas/air pressure according to Section 3-2.

Tools Needed:
5/8, 1-1/8 in

ST-802 185 / Ref. SB-192 441

2-6. Electrical Service Guide

NOTE

For any single or three phase voltage from 208 V to 575 V, the Amperes Input at Rated Load Output is the same for 50 Hertz or 60 Hertz input power. For example, the amperes input for 230 V, 50 Hz, single-phase input power is 35 amperes. The amperes input for 230 V, 60 Hz, single-phase input power is also 35 amperes.

60 Hz Models	Single Phase				Three Phase				
	208	230	460	575	208	230	460	575	
Input Voltage	208	230	460	575	208	230	460	575	
Input Amperes At Rated Output	35	31	16	13	19	17	9	8	
Max Recommended Standard Fuse Or Circuit Breaker Rating In Amperes	50	45	25	20	30	25	15	10	
Reference: 1997 National Electrical Code (NEC)								S-0092-J	

50 Hz Models	Single Phase	Three Phase		
	230	380	400	415
Input Voltage	230	380	400	415
Input Amperes At Rated Output	31	10	10	10
Max Recommended Standard Fuse Or Circuit Breaker Rating In Amperes	50	15	15	15
Reference: 1997 National Electrical Code (NEC)				
S-0092-J				

2-7. Connecting Input Power



Check input voltage available at site.

The Auto-Line™ circuitry in this unit automatically adapts the power source to the primary voltage being applied, from 208 to 575 volts, single- or three-phase, 50 or 60 Hz.

- 1 Input And Grounding Conductors
 - 2 Line Disconnect Device
- See Section 2-6.

For single-phase operation:

- 3 Black And Brown Input Conductor
- 4 Blue Input Conductor
- 5 Insulation Sleeving
- 6 Electrical Tape

Insulate and isolate blue conductor as shown.

▲ Always connect green wire to supply grounding terminal, never to a line terminal. Connect black, brown, and blue wires (L1, L2, L3) to line terminals.

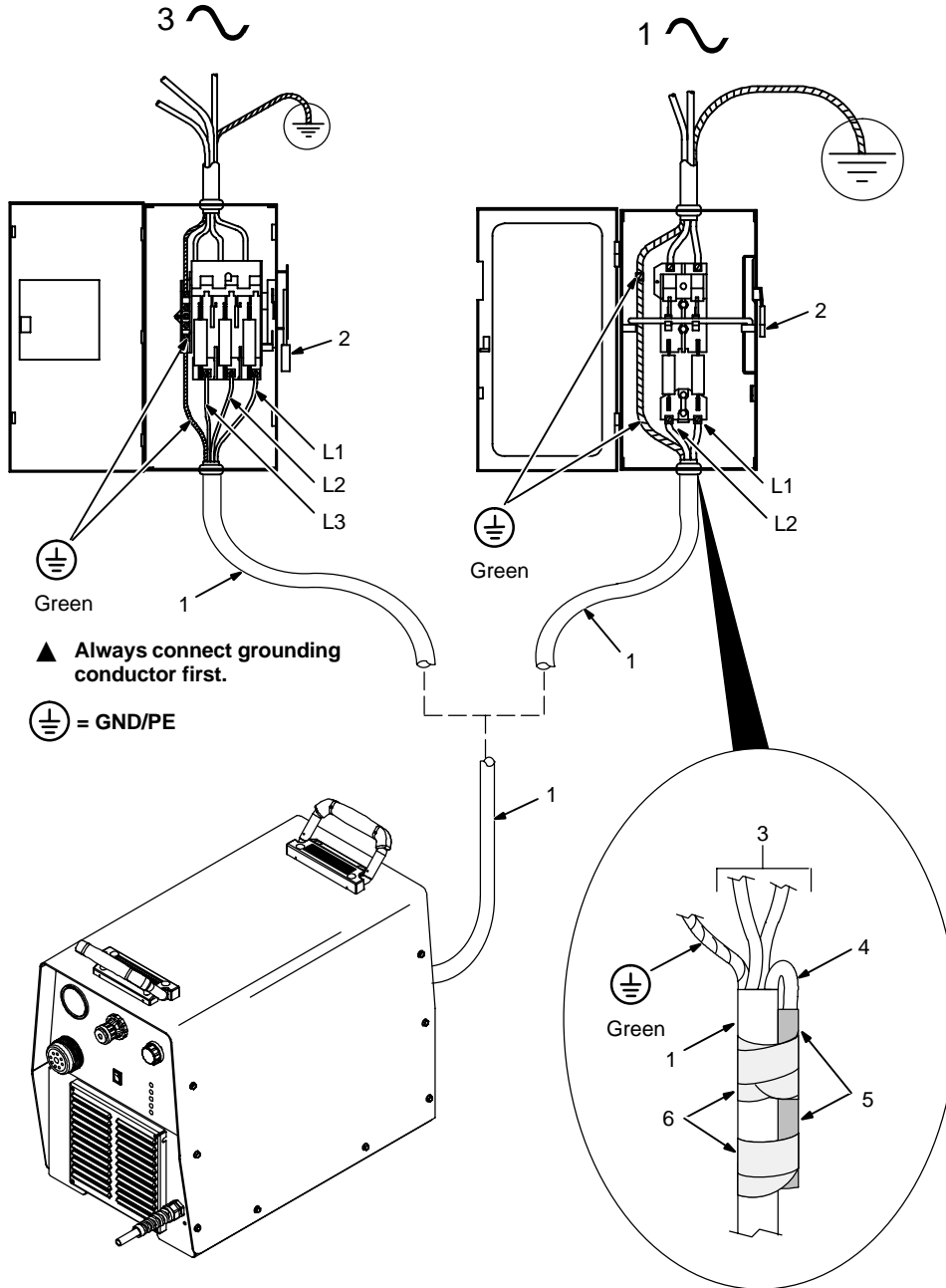

▲ Always connect grounding conductor first.

= GND/PE

Tools Needed:

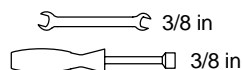

SECTION 3 – OPERATION

3-1. Controls

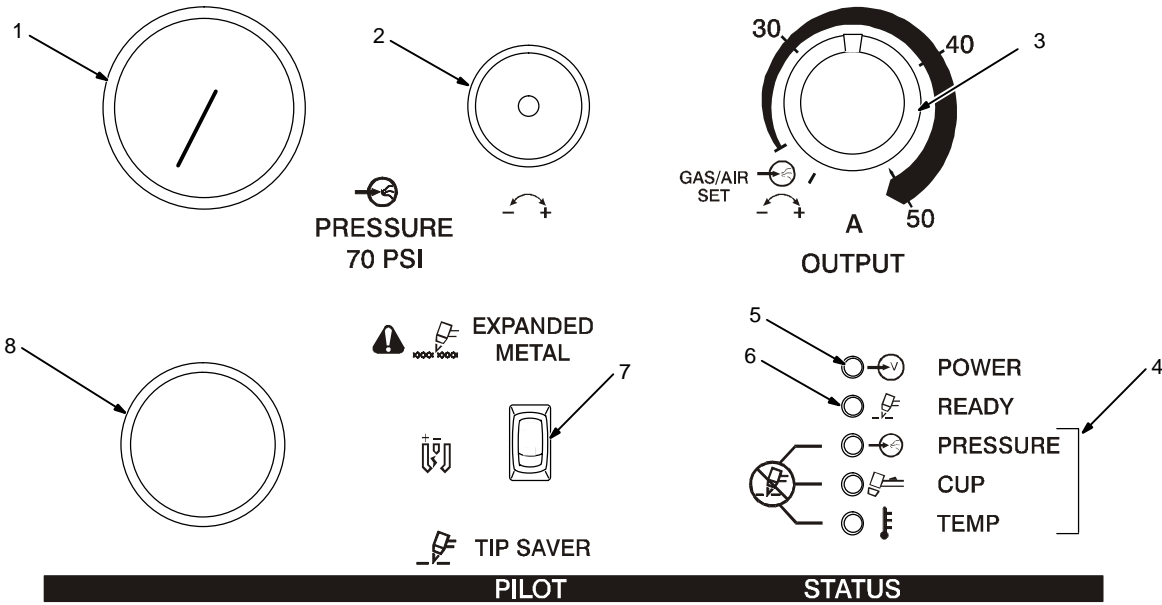

Ref. SB-192441 / Ref. SB-192 452

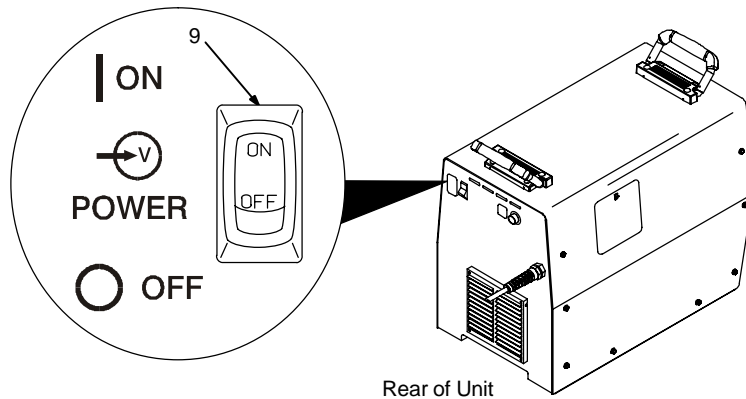

Rear of Unit

- 1 Gas/Air Pressure Gauge
- 2 Gas/Air Pressure Control
- 3 Output Control

Use control to select cutting output in amperes. Gas/air automatically flows at the set pressure.

Use Gas/Air Set area of control range for setting gas/air pressure (see Section 3-2).

- 4 Trouble Lights (see Section 4-2)
- 5 Power Light
- 6 Ready Light

Ready light comes On when unit is On to indicate that all safety shutdown systems are okay. If Ready light does not come On, check trouble lights.

7 Pilot Arc Switch

Use switch to control pilot arc.

Place switch in Expanded Metal position for continuous pilot arc. Use while cutting expanded metals **only**.

The Expanded Metal position keeps the pilot arc in the circuit at all times. Life of

consumables will be significantly reduced while in Expanded Metal mode.

Place switch in Tip Saver position to provide pilot arc output for arc starting only. Use Tip Saver position in most applications to lengthen the life of the torch and its consumables, and to obtain maximum cutting performance.

After the cutting arc goes out, the torch will automatically re-ignite the pilot arc if the trigger is held down.

- 8 Torch Connection Receptacle
- 9 Power Switch

3-2. Setting Gas/Air Pressure

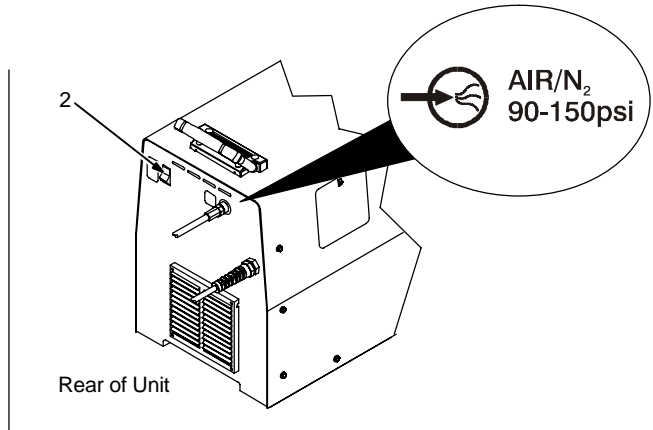
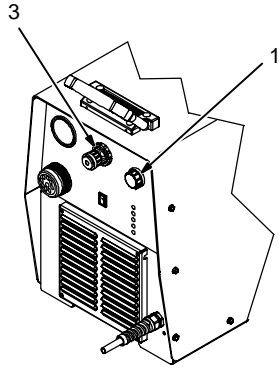

Ref. ST-802 183 / Ref. ST-802 185 / Ref. SB-192 441

Setting Gas/Air Pressure

Place Output Control in Gas/Air Set Position

Power Switch On

Set Controls



Requires
90–150 PSI Supply
(620–1035 kPa)

Turn On Gas/Air Supply



Set To **70 PSI**

Adjust Pressure
On Unit



Select Desired
Amperage To Be-
gin Cutting

1 Output Control

2 Power Switch

Place controls as indicated above. Only gas/

air circuit is activated when the Power switch is turned On with Output Control in Gas/Air Set position.

3 Gas/Air Pressure Adjustment Knob

Pull knob and turn to adjust pressure. Push knob in to lock setting.

Select desired cutting output with Output Control.

3-3. Sequence of Operation



⚠ Do not clean torch by hitting it against a hard surface. Hitting hard surfaces can damage torch parts and stop proper operation.

⚠ Inspect shield cup, tip, and electrode for wear before cutting or whenever cutting speed has been significantly reduced (see torch Owner's Manual). Do not operate torch without a tip or electrode in place.

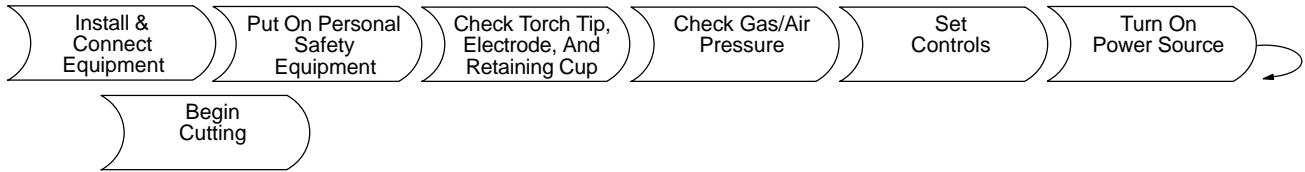

EXAMPLE Of Cutting Operation

⚠ The pilot arc starts immediately when trigger is pressed.

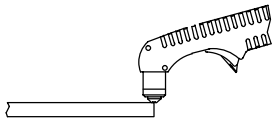

Place drag shield on edge of metal, or allow correct standoff distance – approximately 1/8 in (3 mm).

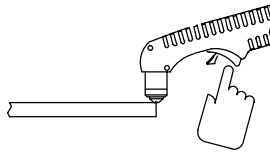

Lift trigger safety lock. Press trigger. Pilot arc starts.

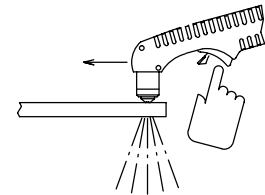

After cutting arc starts, slowly start moving torch across metal.

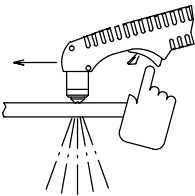

Adjust torch speed so sparks go thru metal and out bottom of cut.

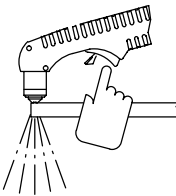

Pause briefly at end of cut before releasing trigger.

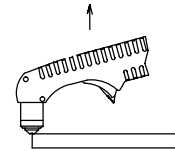











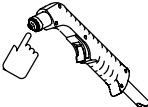
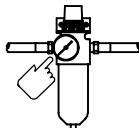

Postflow continues for approx. 5 to 15 seconds after releasing trigger; cutting arc can be instantly restarted during postflow by pressing trigger.

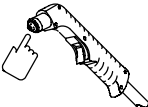
ST-801 400-A

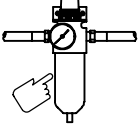
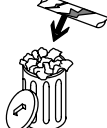
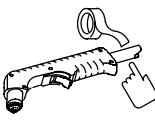
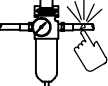
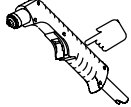
SECTION 4 – MAINTENANCE & TROUBLESHOOTING

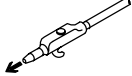
4-1. Routine Maintenance

					 Disconnect power before maintaining.		 <i>Maintain more often during severe conditions.</i>					
 Each Use												
 <p>Check Torch Tip, Electrode, And Shield Cup</p>				 <p>Check Gas/Air Pressure</p>								
 Every Week												
 <p>Check Shield Cup Shutdown System</p>												
 3 Months												
 <p>Replace Unreadable Labels</p>				 <p>Service Air Filter/Regulator Assembly Filter</p>								
 <p>Replace Cracked Parts</p>				 <p>Tape Torn Outer Covering Or Replace Cable</p>								
<p>Check Gas/Air Hose</p> 				 <p>Check Torch Body</p>								
 6 Months												
				<p>OR</p> 					<p>Blow Out Or Vacuum Inside</p>			

4-2. Trouble Lights

 *Difficulty establishing pilot arc may indicate consumables need to be cleaned or replaced.*

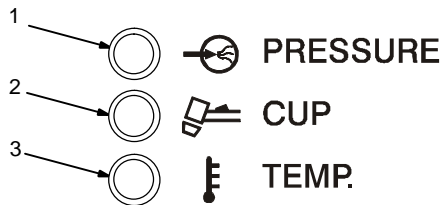

1 Pressure Light

Lights if gas/air pressure is below 40 PSI (276 kPa).

Turn power Off, and check for proper gas/air pressure (see Section 3-2).

2 Cup Light

Lights if shield cup is loose.

Turn power Off, and check shield cup connection (see torch Owner's Manual). Power must be reset whenever the cup shutdown is activated.

Check shield cup shutdown system once a week (see Section 4-3).

3 Temperature Light

Lights if power source overheats (see Section 2-2).

4-3. Checking Shield Cup Shutdown System



 *Power must be reset whenever the cup shutdown system is activated. **Always turn Off power when changing or checking consumables.***

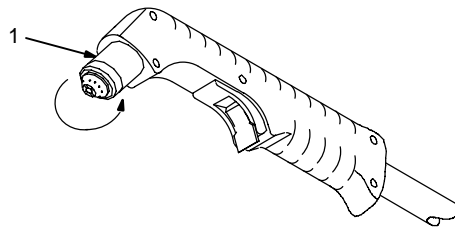

1 Torch Shield Cup

Turn Power On and loosen shield cup. If shutdown system works properly, Ready light goes off and Cup light comes on. If not, immediately turn Off power and have Factory Authorized Service Agent check safety control board PC1 operation.

If system works properly, retighten cup and reset power.

Ref. ST-801 300-A

4-4. Troubleshooting

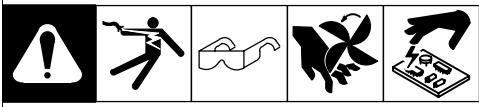
				
Trouble		Remedy		
No pilot arc; difficulty in establishing an arc.	Clean or replace worn consumables as necessary (see torch Owner's Manual).			
	Check for damaged torch or torch cable (see torch Owner's Manual).			
No cutting output; Power light off; Trouble lights off; Ready light off; fan motor FM does not run.	Place Power switch in On position.			
	Place line disconnect device in On position (see Section 2-7).			
	Check line fuse(s) and replace if needed or reset circuit breakers (see Sections 2-6 and 2-7).			
Pilot arc working; no cutting output; Power light on; Ready light on; Trouble lights off; fan motor running.	Be sure work clamp is connected.			
	Clean or replace worn consumables as necessary (see torch Owner's Manual).			
No gas/air flow; Power light on; Ready light on; Trouble lights off; fan motor running.	Have Factory Authorized Service Agent check for proper torch connections. Check operation of gas valve GS1, and check gas/air system for leaks.			
Pressure Trouble light On; Ready light off.	Check for correct gas/air pressure adjustment (see Section 3-2).			
	Check for sufficient gas/air supply pressure (see Section 2-5).			
	Check for dirty air filter/regulator and clean, if needed (see manufacturer's instructions).			
	Check air lines for leaks.			
	Have Factory Authorized Service Agent check pressure switch and control board.			
Cup Trouble light On; Ready light off.	Check torch shield cup (see Section 4-3). Reset power switch.			
	Have Factory Authorized Service Agent check for proper torch connections.			
Temperature Trouble light On; Ready light off.	Inverter heat sink or output heat sink overheating. Allow fan to run; the Trouble light goes out when the unit has cooled.			
	Have Factory Authorized Service Agent check control board.			
Trouble lights not working.	Have Factory Authorized Service Agent check unit.			
Power light flashing, Trouble lights off.	Reset power switch.			

SECTION 5 – ELECTRICAL DIAGRAM

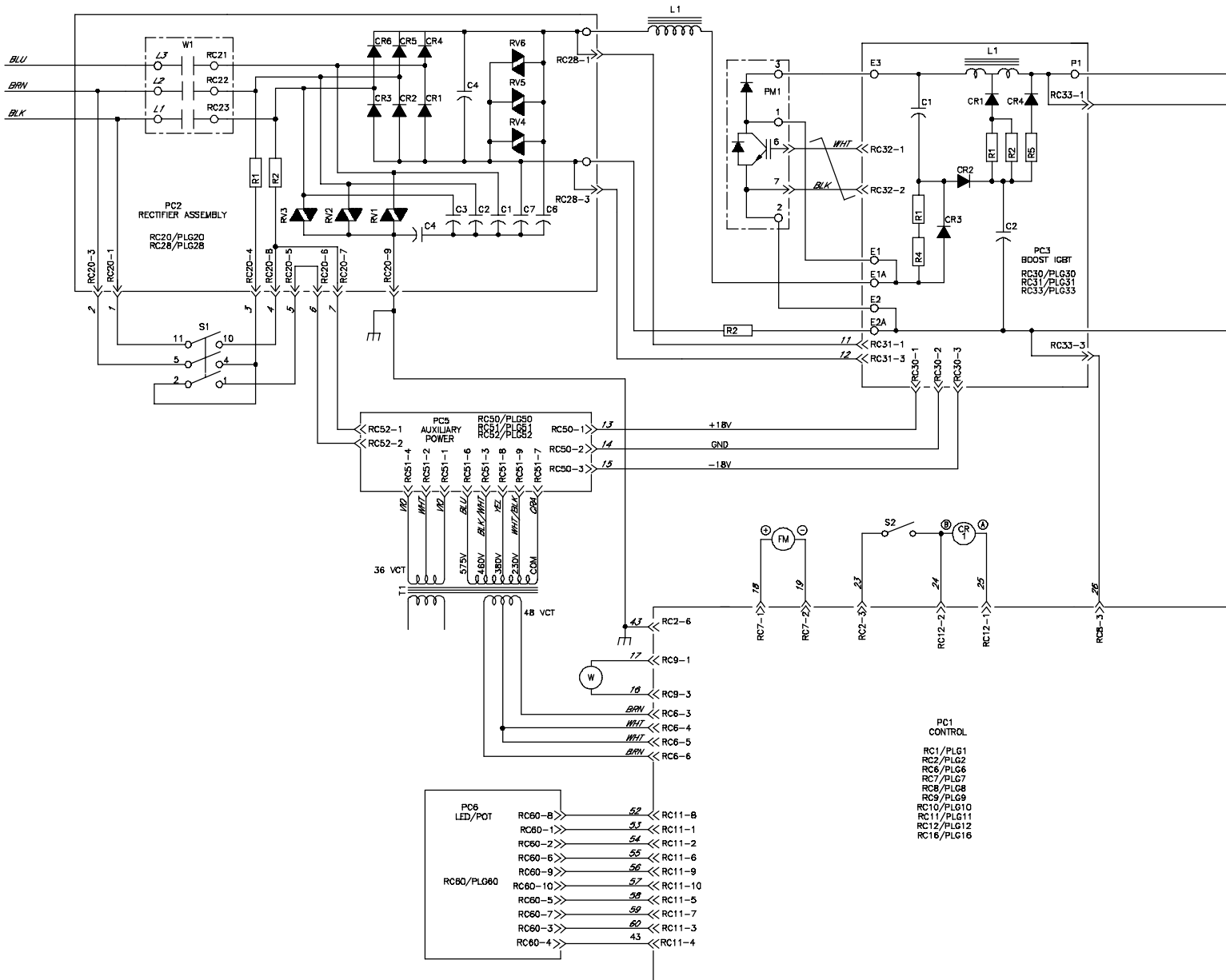
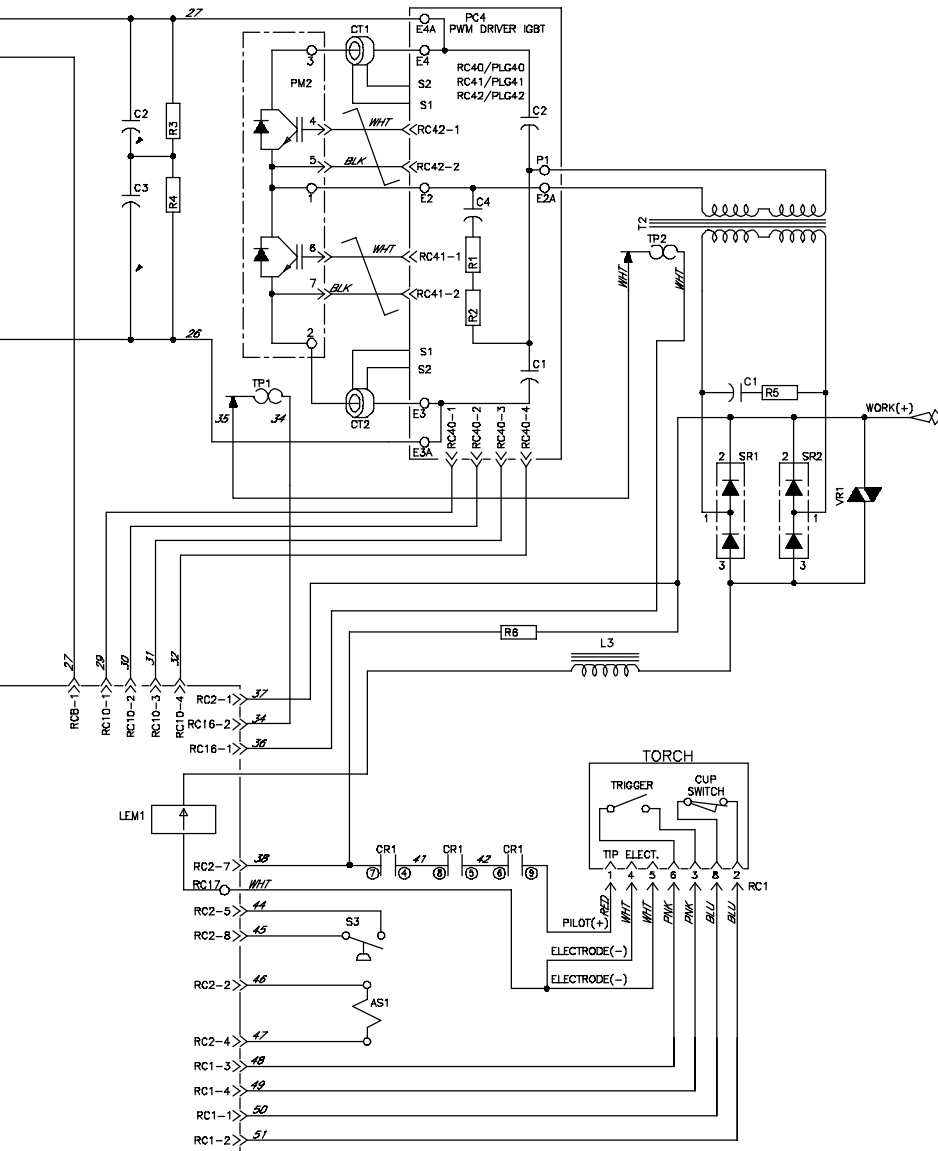

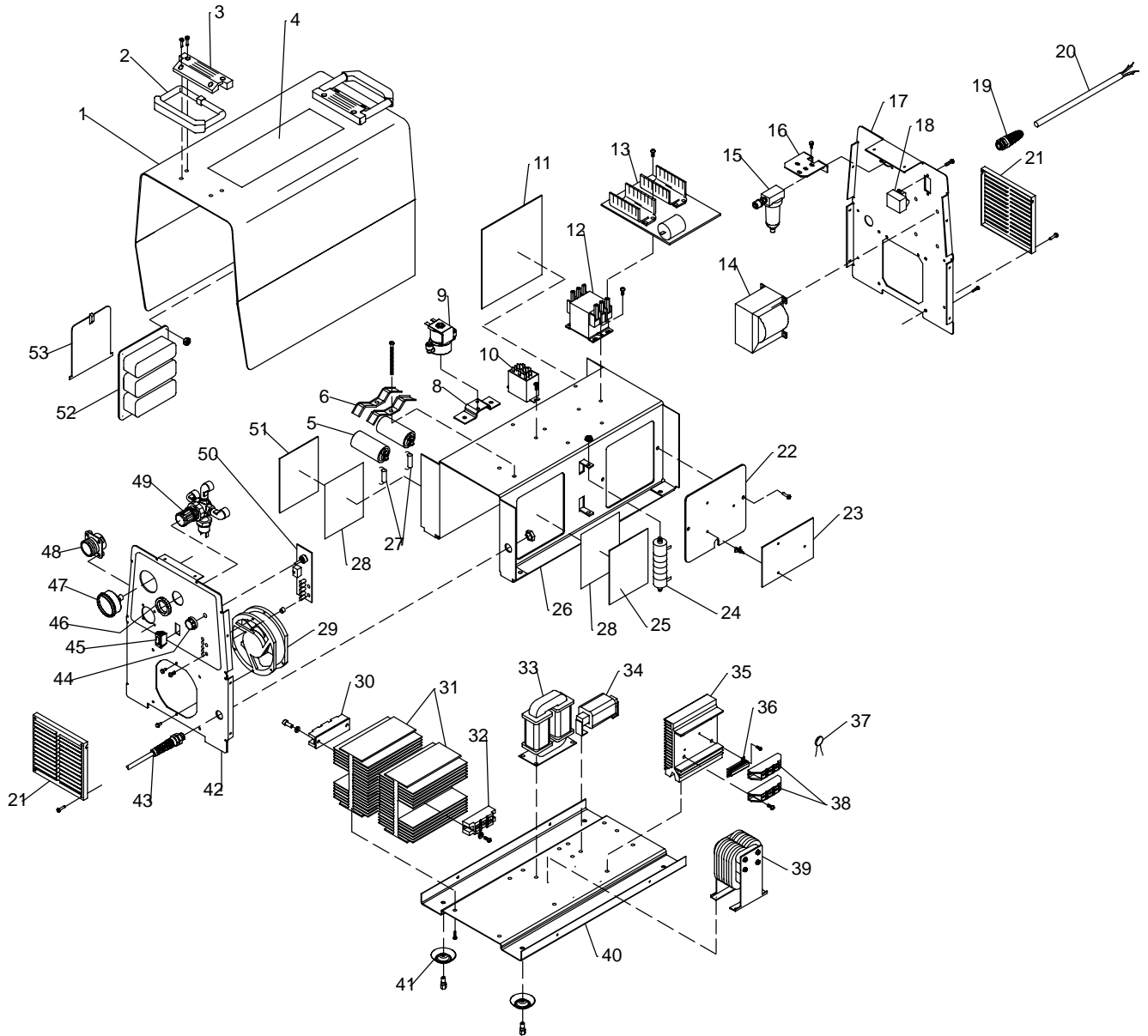

Figure 5-1. Circuit Diagram For Power Source



SECTION 6 – PARTS LIST

 Hardware is common and not available unless listed.



ST-802 184-C

Figure 6-1. Main Assembly

Item No.	Dia. Mkgs.	Part No.	Description	Quantity
----------	------------	----------	-------------	----------

Figure 6-1. Main Assembly

1		187 782	WRAPPER	1
2		126 416	HANDLE, molded plastic	2
3		126 415	CLAMP, saddle	2
4		192 460	LABEL, caution/warning	1
5	C2,C3	193 236	CAPACITORS, buss	2
6		100026-001	CAPACITOR CLAMP	2
8		191 147	BRACKET, mounting solenoid	1
9	AS1	194 428	VALVE, w/fittings	1
10	CR1	191 744	RELAY, pta	1
11	PC1	193 547	CIRCUIT CARD ASSY, control	1
12	W1	194 525	CONTACTOR	1
13	PC2	193 940	CIRCUIT CARD ASSY, rectifier	1
14	T1	194 560	XFMR, aux	1
15		193 450	FILTER, air w/fittings	1
16		187 784	BRACKET, mtg filter	1
17		190 352	PANEL, rear	1
18	S1	194 517	SWITCH, rocker w/leads	1
19		121 276	STRAIN RELIEF	1
20		194 490	CABLE, power	1
21		175 138	BOX, louver	2
22		191 639	DOOR, side	1
23	PC5	192 817	ASSY, pwb autoline w/o bracket	1
24	R6	902006-005	RESISTOR, surge	1
25	PC4	194 205	CIRCUIT CARD ASSY, driver pwm	1
26		194 619	WINDTUNNEL	1
27		193 675	RESISTOR, bleeder	1
28		190 313	INSULATOR, pc card	2
29	FM	922013-001	FAN	1
30	PM1	191 591	KIT, IGBT (914016-002 IGBT)	1
31		101334-001	HEATSINK	2
32	PM2	191 590	KIT, IGBT (914016-001 IGBT)	1
33	L1	107822-001	ASSY, boost inductor	1
34	L3	193 585	ASSY, main inductor	1
35		107813-001	HEATSINK	1
36	C1, R5	101369-003	ASSY, resistor/capacitor	1
37	VR1	107831-001	ASSY, varistor	1
38	SR1, SR2	191 503	KIT, diode (912006-001 diode modules)	2
39	T2	195 662	ASSY, transformer	1
40		191 638	BASE, aluminium	1
41		190 594	FOOT, mtg unit	4
42		190 362	PANEL, front	1
43		169 687	CABLE, work 20ft No. 6 w/strain relief	1
44		174 991	KNOB, pointer	1
45	S2	120 376	SWITCH, rocker SPDT 4A 250VAC On-None-On	1
46		189 554	NUT, panel mount	1
47		190 585	GAUGE, pressure air 0-160psi	1
48		192 893	DISCONNECT, quick ICE-50C	1
49		193 447	REGULATOR/SWITCH, w/fittings	1
50	PC6	192 965	CIRCUIT CARD ASSY, LED/pot	1
51	PC3	194 200	CIRCUIT CARD ASSY, boost	1
52		179 942	CONSUMABLE STORAGE BOX	1
53		179 943	DOOR, consumable storage box	1
			NAMEPLATE, specific front or rear (order by model and serial no.)	1

TRUE BLUE®

WARRANTY

Effective January 1, 1999

(Equipment with a serial number preface of "KK" or newer)

This limited warranty supersedes all previous Miller warranties and is exclusive with no other guarantees or warranties expressed or implied.

LIMITED WARRANTY – Subject to the terms and conditions below, Miller Electric Mfg. Co., Appleton, Wisconsin, warrants to its original retail purchaser that new Miller equipment sold after the effective date of this limited warranty is free of defects in material and workmanship at the time it is shipped by Miller. THIS WARRANTY IS EXPRESSLY IN LIEU OF ALL OTHER WARRANTIES, EXPRESS OR IMPLIED, INCLUDING THE WARRANTIES OF MERCHANTABILITY AND FITNESS.

Within the warranty periods listed below, Miller will repair or replace any warranted parts or components that fail due to such defects in material or workmanship. Miller must be notified in writing within thirty (30) days of such defect or failure, at which time Miller will provide instructions on the warranty claim procedures to be followed.

Miller shall honor warranty claims on warranted equipment listed below in the event of such a failure within the warranty time periods. All warranty time periods start on the date that the equipment was delivered to the original retail purchaser, or one year after the equipment is sent to a North American distributor or eighteen months after the equipment is sent to an International distributor.

1. 5 Years Parts – 3 Years Labor
 - * Original main power rectifiers
 - * Inverters (input and output rectifiers only)
2. 3 Years — Parts and Labor
 - * Transformer/Rectifier Power Sources
 - * Plasma Arc Cutting Power Sources
 - * Semi-Automatic and Automatic Wire Feeders
 - * Inverter Power Supplies
 - * Intellitig
 - * Engine Driven Welding Generators
(NOTE: Engines are warranted separately by the engine manufacturer.)
3. 1 Year — Parts and Labor
 - * Motor Driven Guns (w/exception of Spoolmate 185)
 - * Process Controllers
 - * Positioners and Controllers
 - * Automatic Motion Devices
 - * Robots
 - * IHPS Power Sources
 - * Water Coolant Systems
 - * HF Units
 - * Grids
 - * Spot Welders
 - * Load Banks
 - * SDX Transformers
 - * Miller Cyclomatic Equipment
 - * Running Gear/Trailers
 - * Plasma Cutting Torches (except APT, ZIPCUT & PLAZCUT Models)
 - * Deutz Engines (outside North America)
 - * Field Options
(NOTE: Field options are covered under True Blue® for the remaining warranty period of the product they are installed in, or for a minimum of one year — whichever is greater.)
4. 6 Months — Batteries
5. 90 Days — Parts
 - * MIG Guns/TIG Torches

- * APT, ZIPCUT & PLAZCUT Model Plasma Cutting Torches
- * Remote Controls
- * Accessory Kits
- * Replacement Parts (No labor)
- * Spoolmate 185

Miller's True Blue® Limited Warranty shall not apply to:

1. Items furnished by Miller, but manufactured by others, such as engines or trade accessories. These items are covered by the manufacturer's warranty, if any.
2. Consumable components; such as contact tips, cutting nozzles, contactors, brushes, slip rings, relays or parts that fail due to normal wear.
3. Equipment that has been modified by any party other than Miller, or equipment that has been improperly installed, improperly operated or misused based upon industry standards, or equipment which has not had reasonable and necessary maintenance, or equipment which has been used for operation outside of the specifications for the equipment.

MILLER PRODUCTS ARE INTENDED FOR PURCHASE AND USE BY COMMERCIAL/INDUSTRIAL USERS AND PERSONS TRAINED AND EXPERIENCED IN THE USE AND MAINTENANCE OF WELDING EQUIPMENT.

In the event of a warranty claim covered by this warranty, the exclusive remedies shall be, at Miller's option: (1) repair; or (2) replacement; or, where authorized in writing by Miller in appropriate cases, (3) the reasonable cost of repair or replacement at an authorized Miller service station; or (4) payment of or credit for the purchase price (less reasonable depreciation based upon actual use) upon return of the goods at customer's risk and expense. Miller's option of repair or replacement will be F.O.B., Factory at Appleton, Wisconsin, or F.O.B. at a Miller authorized service facility as determined by Miller. Therefore no compensation or reimbursement for transportation costs of any kind will be allowed.

TO THE EXTENT PERMITTED BY LAW, THE REMEDIES PROVIDED HEREIN ARE THE SOLE AND EXCLUSIVE REMEDIES. IN NO EVENT SHALL MILLER BE LIABLE FOR DIRECT, INDIRECT, SPECIAL, INCIDENTAL OR CONSEQUENTIAL DAMAGES (INCLUDING LOSS OF PROFIT), WHETHER BASED ON CONTRACT, TORT OR ANY OTHER LEGAL THEORY.

ANY EXPRESS WARRANTY NOT PROVIDED HEREIN AND ANY IMPLIED WARRANTY, GUARANTY OR REPRESENTATION AS TO PERFORMANCE, AND ANY REMEDY FOR BREACH OF CONTRACT TORT OR ANY OTHER LEGAL THEORY WHICH, BUT FOR THIS PROVISION, MIGHT ARISE BY IMPLICATION, OPERATION OF LAW, CUSTOM OF TRADE OR COURSE OF DEALING, INCLUDING ANY IMPLIED WARRANTY OF MERCHANTABILITY OR FITNESS FOR PARTICULAR PURPOSE, WITH RESPECT TO ANY AND ALL EQUIPMENT FURNISHED BY MILLER IS EXCLUDED AND DISCLAIMED BY MILLER.

Some states in the U.S.A. do not allow limitations of how long an implied warranty lasts, or the exclusion of incidental, indirect, special or consequential damages, so the above limitation or exclusion may not apply to you. This warranty provides specific legal rights, and other rights may be available, but may vary from state to state.

In Canada, legislation in some provinces provides for certain additional warranties or remedies other than as stated herein, and to the extent that they may not be waived, the limitations and exclusions set out above may not apply. This Limited Warranty provides specific legal rights, and other rights may be available, but may vary from province to province.

Warranty Questions?

Call

1-800-4-A-MILLER

for your local

Miller distributor.

Your distributor also gives you ...

Service

You always get the fast, reliable response you need. Most replacement parts can be in your hands in 24 hours.

Support

Need fast answers to the tough welding questions? Contact your distributor. The expertise of the distributor and Miller is there to help you, every step of the way.





Owner's Record

Please complete and retain with your personal records.

Model Name Serial/Style Number

Purchase Date (Date which equipment was delivered to original customer.)

Distributor

Address

City

State Zip



Resources Available

Always provide Model Name and Serial/Style Number.

<p>Contact your Distributor for:</p> <p>To locate distributor nearest you call 1-800-4-A-Miller</p>	<p>Welding Supplies and Consumables</p> <p>Options and Accessories</p> <p>Personal Safety Equipment</p> <p>Service and Repair</p> <p>Replacement Parts</p> <p>Training (Schools, Videos, Books)</p> <p>Technical Manuals (Servicing Information and Parts)</p> <p>Circuit Diagrams</p> <p>Welding Process Handbooks</p>
---	---

<p>Contact the Delivering Carrier for:</p> <p>For assistance in filing or settling claims, contact your distributor and/or equipment manufacturer's Transportation Department.</p>	<p>File a claim for loss or damage during shipment.</p>
--	---

Miller Electric Mfg. Co.

An Illinois Tool Works Company
1635 West Spencer Street
Appleton, WI 54914 USA

International Headquarters—USA

USA Phone: 920-735-4505 Auto-Attended
USA & Canada FAX: 920-735-4134
International FAX: 920-735-4125

European Headquarters – United Kingdom

Phone: 44 (0) 1204-593493
FAX: 44 (0) 1204-598066

www.MillerWelds.com



Miller
The Power of Blue.